

HERE BOY!

AbiHall®

Quilt is 50" x 70".

Fabric Requirements

A Blocks

1 Here Boy Layer Cake* (35230LC)

A Block Background

1 yard (35231 11)

Bones: 7/8 yard (Bella Solid 9900 200)

Bone Background

1 3/4 yards (35232 12)

Binding: 5/8 yard (35233 13)

Backing: 3 1/4 yards

*Layer Cake = 42-10" squares

*Featured fabric is Here Boy by
Abi Hall for Moda*

moda

MODAFABRICS.COM

WEB35230 — SUGGESTED RETAIL \$6.00



Quilt is 50" x 70".

HERE BOY!

AbiHall®

moda

HERE BOY!

AbiHall

Quilt is 50" x 70".

Fabric Cutting

A Blocks

From EACH of 17 Layer Cake 10" squares cut
 1-6½" square
 2-2½" squares
 From the remaining Layer Cake squares cut
 a total of 34-2½" squares

A Block Background

5-6½" x width of fabric strips
 From the strips, cut 68-6½" x 2½"

Bones

3-3¼" x width of fabric strips
 From the strips, cut 72-3¼" x 1½"
 9-1½" x width of fabric strips
 From the strips, cut 36-1½" x 10½"

Bone Background

4-8¼" x width of fabric strips
 From the strips, cut 18-8¼" squares,
 cut once on the diagonal to make
 36 half square triangles
 2-4" x width of fabric strips
 From the strips, cut 18-4" squares,
 cut once on the diagonal to make
 36 half square triangles
 2-5" x width of fabric strips
 From the strips, cut 36-5" x 1½"
 3-1½" x width of fabric strips
 From the strips, cut 72-1½" squares
 3-1¼" x width of fabric strips
 From the strips, cut 72-1¼" squares
 2-1" x width of fabric strips
 From the strips, cut 72-1" squares

Binding

7-2½" x width of fabric strips
 Sew the strips end to end to make the
 binding.

moda

Construction (Use a ¼" seam allowance. Press in the direction of the arrows.)

1 Block A

Arrange and sew in 3 rows, 4-2½" corner squares, 1-6½" center square, and 4-6½" x 2½" background rectangles as shown. Join the rows. Make 17 Block As.

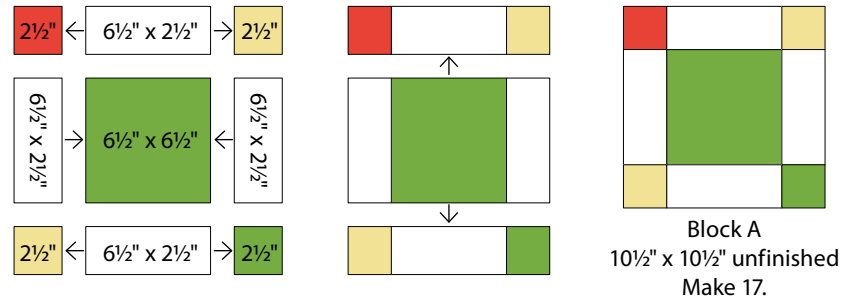

2 Bone Block

- (A) Draw a diagonal line from corner to corner on the wrong side of 72-1½" and 72-1¼" bone background squares.
 (B) Layer a marked 1¼" square right sides together on the left end of a 3¼" x 1½" bone rectangle. Sew on the diagonal line. Trim ¼" from the sewn line. Press to the corner to form a triangle. Repeat with a marked 1½" square on the opposite end of the same rectangle. Make 36 Unit As.

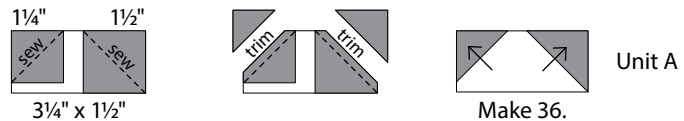

- (C) Layer a marked 1½" square right sides together on the left end of a 3¼" x 1½" bone rectangle. Sew on the diagonal line. Trim ¼" from the sewn line. Press to the corner to form a triangle. Repeat with a marked 1¼" square on the opposite end of the same rectangle. Make 36 Unit Bs.

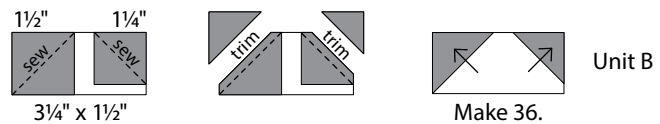

- (D) Sew a Unit A and Unit B to each side of a 5" x 1½" bone background rectangle. Make 36 bone tips.

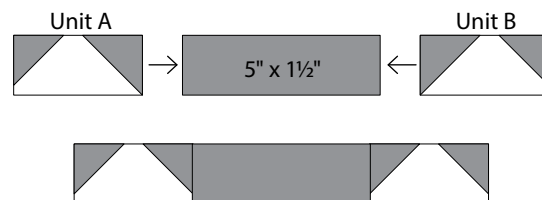

(E) Draw a diagonal line from corner to corner on the wrong side of 72-1" bone background squares. Layer a marked square right sides together on a $10\frac{1}{2}$ " x $1\frac{1}{2}$ " bone rectangle. Sew on the diagonal line. Trim $\frac{1}{4}$ " from the sewn line. Press to the corner to form a triangle. Repeat on the opposite end of the same rectangle. Make 36 bone centers.

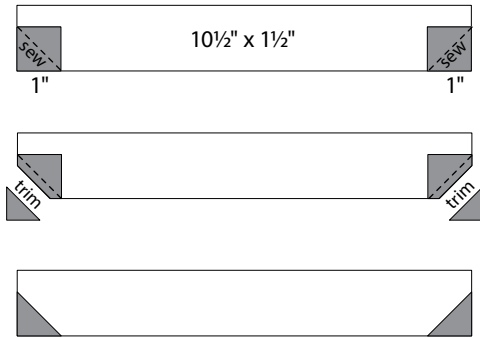

Bone centers
 $10\frac{1}{2}$ " x $1\frac{1}{2}$ " unfinished
 Make 36.

(F) Join 2 bone tips and 2 bone centers as shown to make 1 bone. Sew an $8\frac{1}{4}$ " bone background half square triangle to 2 sides of the bone as shown. Sew a 4" bone background half square triangle to the remaining 2 sides as shown. Trim the block to $10\frac{1}{2}$ " square. Make 18 bone blocks.

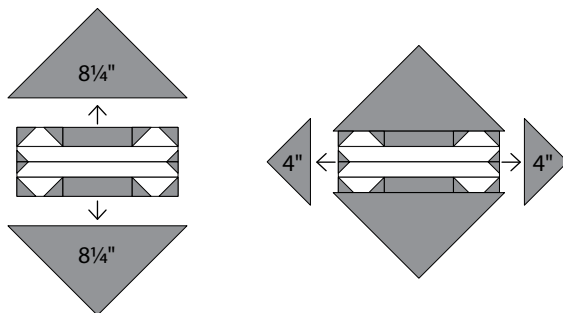
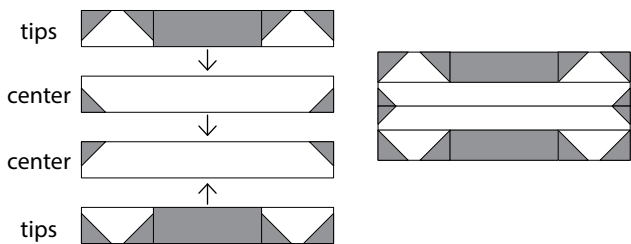

Bone Block
 $10\frac{1}{2}$ " x $10\frac{1}{2}$ " unfinished
 Make 18.

3 Arrange and sew in 7 rows, 18 Bone blocks and 17 Block As as shown. Press toward Block A. Join the rows. Layer, quilt and bind.

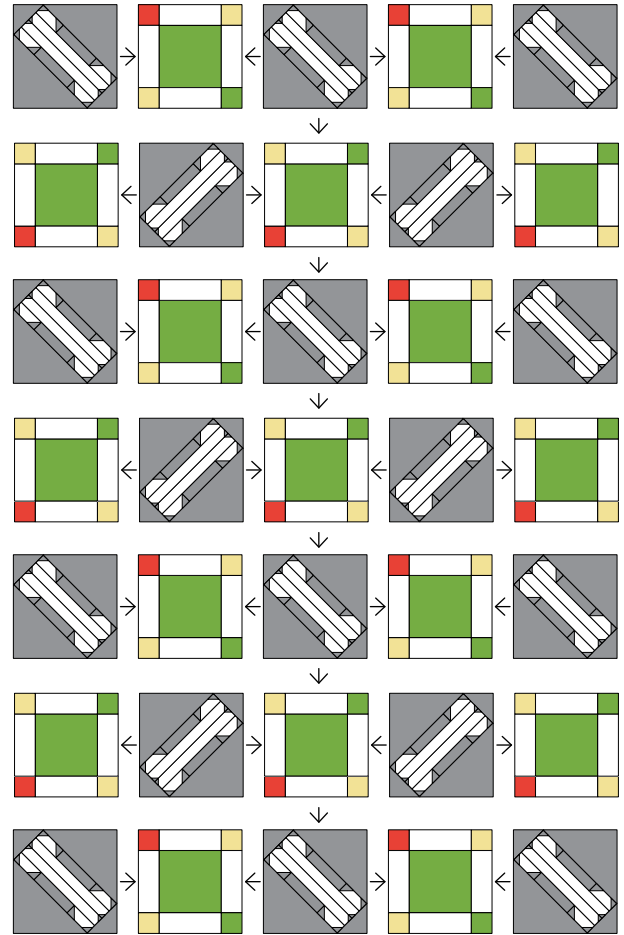

moda

